



Gromfast

Grommet, Eyelet & Fastener
Products Innovative
Manufacturer



PRODUCT CATALOGUE



About Us

Gromfast is global leading manufacturer wide range eyelets, grommets, eyelet & grommet machines, dies, tools, fastener products, metal accessories, snap button, rivets, attaching machines located in the industrial district of İkitelli in İstanbul Turkey.

Gromfast is world wide brande progressed beyond metal art performance, machines, dies, tools grommet manufacturing thanks to 74 countries customers.

We can say proudly that most of important European countries, USA, Asia pasific countries official governments choosed Gromfast brande grommet machines, grommets, dies and tools due premium quality and experienced art performance test.

One of our main goal is to develope products that are integrated with our wide range metal grommets, dies and machines.

Our product research and development department creates new innovative metal grommet, dies, machinery in order to meet customer's requirements.

We prefer to work with our authorized distributors all over the world.

We also protect our distributors regarding quality and price policy.

Thank you for the trust invested in us.



Catalog Analytic Index

- Page-1:GF-99 Full Automatic Grommet Machine, GF-89 Full Automatic Grommet Machine,
- Page-2:GF-30 hydraulic grommet machine, GF-89-B full automaic grommet machine
- Page 3:GF-10-B Semi Automatic Grommet Machine, GF-10 Semi Automatic Grommet Machine
- Page 4:GF-104 Professional Grommet Hand Press,GF-20 Pneumatic Grommet Machine
- Page 5:GF-3 Stroking Grommet Hand Press, GF-2 stroking grommet hand press
- Page 6:GF-1 eyelet hand plier and tools, GF-107 universal hand press & tools,GF-101 Eyelet hand press
- Page 7:Self piercing grommet made of brass, made of steel and stainless steel
- Page 8:Self piercing grommet dies stainless steel, self piercing grommet and auto neck washers types
- Page 9:Curtain grommet and dies tools
- Page 10:Galvanized aluzinch DIN series grommets and dies
- Page 11:Turnable lock button plastic 42x22 oval grommet compatiabile and hand tools
- Page 12:Just do it yourself grommet blister sets with hand tools, repair kits, inox ring snaps fastener sets
- Page 13:Hole Piercer dies, ring snaps, ring snap dies
- Page 14:Spring snaps dies, spring snaps, open cap prong snaps and dies
- Page 15:Closed cap prong fastener and dies, double cap rivet and dies.
- Page 16:Singel cap rivets and dies, covered buttons, nail covered buttons, GF-3 covered button machine sets
- Page 17:Strap staple belt cramps, 42x22 metal turnable lock buttons for 42x22 oval eyelet
- Page 18:Rocking staples, over center buckles for TIR, over center buckle plates fasteners
- Page 19:Metal hooks for over center buckles and hooks with webbing sets for trailer and TIR.
- Page 20:TIR pvc steel cables, elastic cords, plastic steel roof cables.
- Page 21:TIR stretch mechanisms, plastic hooks for TIR, Trailer,s hooks, d rings, o rings, spanzets, weldable webbings pvc cords
- Page 22:Trailer rolls, adapters, tarpaulin sewing yarns, wheel rollers, spanzet stretch buckle
- Page 23:Trailer fasteners, trailer plastic roof slides, roof overhang tires, roof ceiling fastening buckles, roof profiles
- Page 24:Cristal pvc transparant. pvc coated tarpaulin fabrics
- Page 25:Tent awnings mechanisms, awnings fasteners, tent peg.

Product Code:GF-99 full automatic grommet & eyelet machine (Electro Pneumatic)

Working Electric Power :220 v (50/60 Hz) or 110 V for UK & USA optional

Working Air Pressure Requirement:8 bar Air Compressor-200 Litre

Weight:57 Kg-Ce certified

Wooden box dimension:80x80x60 cm

Throat depth of Machine: 350 mm

2500/2600 pcs grommet attaching capacity per hour.

GF-99 can attach #1(8mm)SPG-ANW,#2(10mm)SPG-ANW,
#3(12mm)SPG-ANW, #4(16mm)SPG-ANW.

(SPG:Self Piercing grommet, ANW:Auto Neck Washer)

16 mm pvc tarpaulin 12mm pvc tarpaulin 10mm & 12mm grommet vinly pvc
1600 gram x4 layer 1600 gram x2 layer 1200 gam x2 layer



Double feeding telescopic system , durable assembly.

Emergency stop buton · Foot pedal operated.

Mobile base transportable system , optional machine can fix on bench or table.

Optional we can add table for GF-99 full automatic grommet machine.

GF-99 machine provide fast and effective solutionon for large format banner makers,
pvc tarpaulin, maritime fabric, millitary textile ,fabric textile and other tecnical textile.

You can get perfect finishing onto thicker material through GF-99 full automatic machine

You can apply GF-99 machine,self piercing grommet and auto neck washer combination
onto thicker materials 1200 gram pvc tarpaulin x 4 layer in one action, no need to punch.

Product Code:GF-89 Full Automatic Servo Motor Controlled Grommet Machine

3 year warranty Ce certified

Servo Motor Controlled -Fast Machine

Working Electric Power :220 v (50/60 Hz)or 110 volt optional for USA and UK users

Working Air Pressure Requirement:6 bar 50 litre Air mini Compressor .

Weight:64 Kg

Dimensions :155cm X 85 cm x60cm -Throat depth of Machine:150 mm

4000 pcs grommet attaching capacity per hour.

Double feeding telescopic system , durable assembly.

Foot pedal as well as hand button operated can work.

Mobile base portable system optional , alternatively machine can fix on
table.

Laser pointer red color- Electronic digital counter

GF-89 can attach #1(8mm)SPG-ANW,#2(10mm)SPG-ANW,
#3(12mm)SPG-ANW, #4(16mm)SPG-ANW.

(SPG:Self Piercing grommet, ANW:Auto Neck Washer)

GF-89 can attach 8 mm ,10 mm,12mm,16 mm self piercing
eyelet onto thickermaterials 900 gram pvc x4 layer

,in one action no need to punch hole

GF-89 is ideal for technical textile industry, pvc industry ,fashion textile
maritime , military textile , truck trailer cover projects ,sign banner, tent
canvas,mesh,tarpaulin,tarp,webbing.

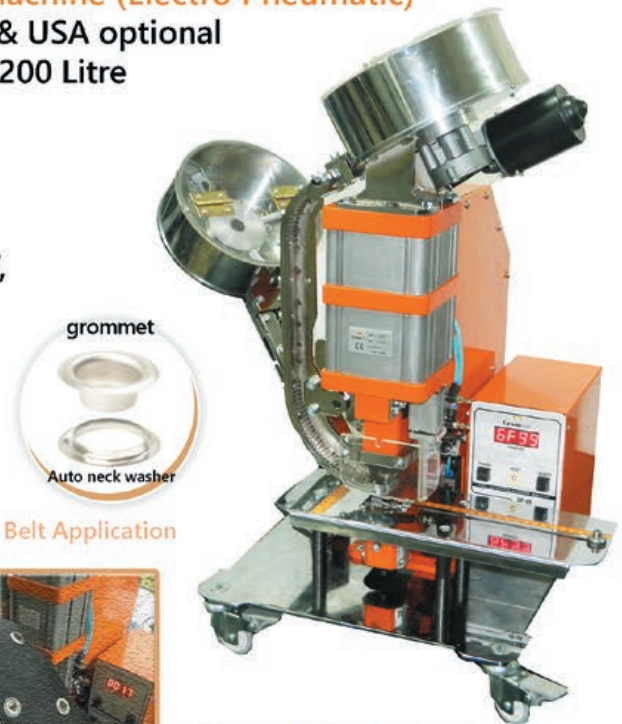

GF-99 Military Belt Application



GF-99 Webbing + Mesh Banner

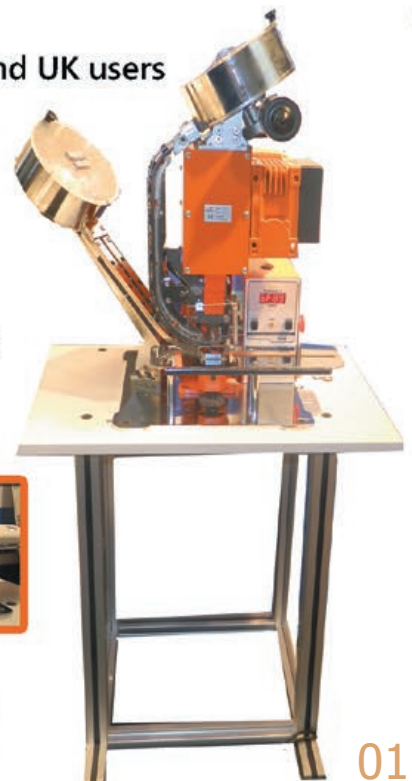

Machine Code: GF-30 Hydraulic Grommet Machine Machine -3 Year Warranty

Box dimension:60x80x130 cm wood box

Net weight:116 kg net -Gross weight :130 kg with wood box

Power:220 V and optional may conver 110 V for UK -USA

3,5 Tone impact force capacity poweful hydrauic grommet machine

GF-30 have strong sheet metal durable cabin

GF-30 have strong platina metal assembly .

GF-30 can attach 66mm,50mm,40mm,30mm,

25mm,20mm round and oval 42x22

oval 40x20, oval 40x10, oval 22,5x13,5mm ,

oval 17x11 mm eyelet

GF-30 is ideal for industrial, pvc tarpaulin applications ,

home textile curtains,awnings.

GF-30 have stainless steel

high quality chrome eyelet

alignment plate.

CE certificated 3 year warranty

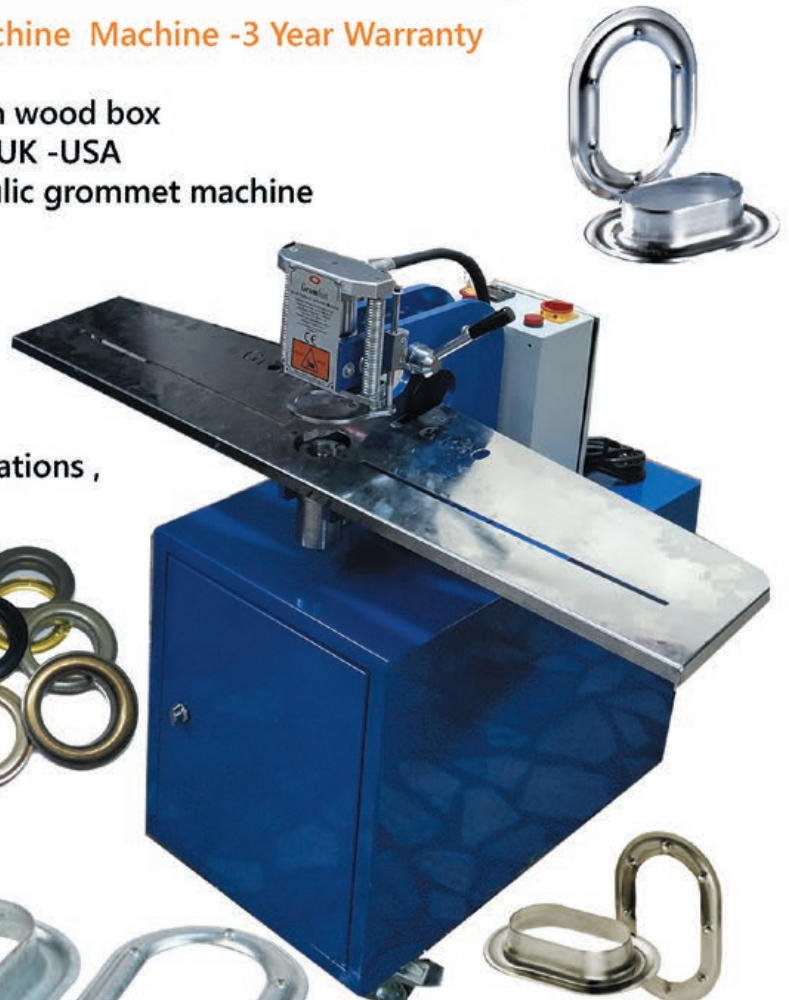

Machine Code: GF-89-B full automatic grommet & eyelet machine (Driver Motor Controlled)

Box dimension:60x40x1125 cm wood box

Net weight:125 kg net -Gross weight :135 kg with wood box

Power:220 V and optional may conver 110 V for UK -USA

Air pressure requirement: 4 bar 25 litre for cleaning channel

3600 pcs grommet eyelet or metal accessory attaching per hour fast machine.

CE certificated 3 year warranty

Durable Assembly - Optional orange and gray color available.

Foot pedal operated-Laser pointer red color

GF 89-B can attach #1,7(3,6mm) ,#00(4,5mm) ,

#0(5 mm) #1-J (6 mm), #1(8mm) eyelet & auto neck washer ,

#2(10mm) , #3(12mm) #4(16mm) grommet with auto neck washer, and all

jean buttons, rivets,snap buttons, ring snaps , plastic snaps ,spring snaps

prong snaps.





GF-10-B Semi Automatic Grommet Machine (3 Year Warranty)

Interchangeable dies setting
 Heavy duty durability
 Easy to carry.
 Suitable numerous materials
 3 Year Warranty-GF-10-B can attach 40 pcs strike /1 minute
 Parts and service available
 Machine body made of high quality best quality iron casting laser cutting.
 Impact Press Force:2000 kg/ cm² (2 tone)
 Working Pressure:8 Bar required (minimum 100 litre)
 GF-10-B works 3,5 mm up to 20 mm as 1 step self piercing grommet dies
 & 25 mm ,30mm,40mm,50 mm 2 step all in one dies
 Hand security ring Ce certificated.
 GF-10-B can fasten on bench or table portable
 GF-10-B can work with any small compressor.
 GF-10-B can attach all size grommets smallest up to biggest size inside hole 66 mm eyelet
 GF-10-B can attach all kind of metal buttons, rivets and accessories



Portable version:63x33x40 box dimension
 Gross weight:23 kg

Table Version 62x42x115 cm gross weight wood box
 Gross weight:27 kg

You can attach 42mmx22mm,40mmx10mm ,23.5mmX13,5mm,17mmX11mm oval eyelet
 40mm,50mm,25mm,30mm,20mm ,18mm ,16mm,14mm,
 12mm,10mm,8 mm round eyelet



40 mm curtain eyelet
 40 mm tarpaulin round

Product Code:GF-10 Semi Automatic Grommet Machine (3 Year Warranty)

Interchangeable dies settings, Applicable dies settings.
 Self Piercing Grommet dies #1.7 (3,5mm) up to #6,5(20mm)
 Maximum inside 20mm outside 36 mm eyelet grommet dies
 All type and size snap button dies , ring snap dies,spring,prong snaps dies
 All type rivet types, double cap , jean rivet dies , single cap rivet tubular rivet dies
 All kind of metal jean button and other metal buton dies.
 Hole piercer dies : 1,5mm up to 25 mm inside hole , (Maximum 25mm hole piercer dies)
 Working pressure :8 bar -50 litre compressor required
 3 Year Warranty-Ce Certificated



Parts and service available- Portable version 52x33x40 cm box dimension gross weight:18 kg
 Portable version GF-10 semi automatic

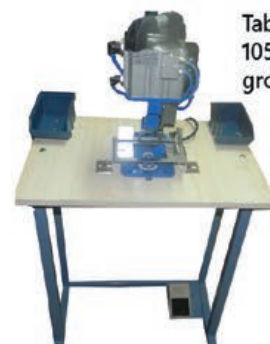
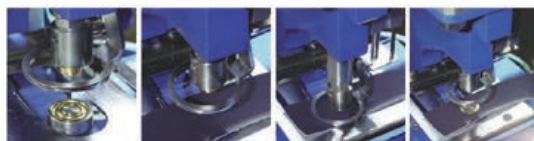

Table Version
 105x62x42 wood box dimension
 gross weight:23 kg



Machine Code: GF-104 Professional Big Grommet Hand Press -3 Year Warranty

GF-104 Premium Grommet Hand Press Advantages ;

Practical ease of use. Interchangeable dies setting, Heavy duty durability

Easy to carry. Suitable numerous materials, 3 Year Warranty

Parts and service available ,Gross weight:8,5 kg /1 pcs

Machine body made of high quality best quality iron casting raw material

compatible with all self piercing grommet & eyelet dies number #1.7 up to #5.5 , and all size hole piercer dies, all size snap button dies, rivet dies, jean button dies.

Box dimension :59x35x25 (5 pcs inside box gross weight:39 kg 5 pcs GF-104

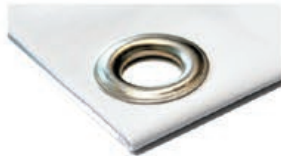

GF-104 can attach inside hole 25 mm grommet maximum

Weight 8.5 kg-18,7 IBS

Throat Depth Dimension 120 mm 4.72 inches -4 23/32 inch

Height Dimension 440 mm 17,33 inches

Width Dimension 90 mm 3,54 inches- 3 35/64"

Depth Dimension 230 mm 9 1/16 "

Bottom Die adaptor hole 9,5 mm 1/2 inch

Top Of Die Screw 6,35 mm 1/4 inch

GF-104 extra accessories
grommet alignment tool



GF-20 Pneumatic Grommet Machine (3 year warranty Ce certificated) 1 step auto dies machine

Air pressure requirement:8 Bar -300 litre minimum

Interchangeable automatic dies :Round 50,40,30 25,20,18,16,12,10,8mm automatic dies

Oval 40x10, 42x22,40x20,23,5x13,mm,17x11mm oval eyelet automatic dies

Hand guard safety system

Ce certificated -3 year warranty

GF-20 have wheels , you can fasten up onto table.

Easy to carry. GF-20 can attach 45 pcs automatically /per minute



PORTABLE VERSION-GF-20
Gross weight:51 kg
65x60x80 cm portable version



TABLE VERSION-GF-20
65x60x120
Gross weight:65 kg



Machine Code: GF-3 Stroking Grommet Hand Press -3 Year Warranty

Net Weight 14,5 kg 32 IBS- Gross weight:16,5 kg

Box dimension:21x42x33 (1 pcs inside)

Throat Depth Dimension 73 mm 2 3/4 "

Height Dimension 420 mm 17,33 inches

Width Dimension 160 mm 3,54 inches- 3 35/64"

Depth Dimension 400 mm 9 1/16 "

Bottom Die adaptor hole 11,8 mm 1/2 inch

Top Of Die Screw 6,35 mm 1/4 inch

Compatible curtain round grommet dies sizes:

#7,5(25mm),#8,5(30mm),#12(40mm),#15(50mm)

Curtain grommet and big size grommets all

Compatible Oval Grommet sizes 40x20 oval grommet,40x22 oval grommet all size



GF-2 Stroking Grommet Hand Press (3 Year Warranty)

Adjustable Stroke Level

Special impact force level adjustment, you can raise and unraise impact force according to your using material fabric and metal accessories.

Spring and assembly engineering design provide that apply grommet on material with minimum effort. GF-2 can attach maximum 20 mm inside hole grommet.

Spring throw back after the settings metal grommets or etc automatically

1,3 Tone impact force capacity.

Interchangeable dies setting (compatible all size self piercing grommets ,rivets,snaps dies)

Heavy duty durability,Easy to carry,Suitable numerous materials

3 Year Warranty.Parts and service available

Machine body made of high quality best quality iron casting raw material

Net Weight 19 kg 18,7 IBS

Gross weigh:21 kg

Box dimension:59x35x25(11 pcs)

Throat Depth Dimension 140 mm 5 2/4"

Height Dimension 520 mm 20 1/2"

Width Dimension 200 mm 7 3/4"

Depth Dimension 300 mm 12 1/4 "

Bottom Die adaptor hole 11,8 mm 1/2 inch

Top Of Die Screw 6,35 mm 1/4 inch

Using Areas:Attaching metal accessories,marking bending, riveting fastener products



Machine Code: GF-1 Eyelet Hand Plier

1-Weight:0,650 kg

2-Portable ,easy to use.

3-Made of high quality aluminium

4-Supported die:#1 SPGW ,#2 SPGW ,#3SPGW grommet die and 15 mm ring snap die for GF-1

Applications: Techt textile industry ,sign banner industry,sail industry,maritime sailing, tent, brenda applications



15 mm ring snap dies for GF-1
Product code:GF-1-15mm R-S-B-D Set

Grommet dies for GF-1 hand plier
Product code:GF-1-number 1(8mm) grommet die
Product code:GF-1-number 2(10mm) grommet die
Product code:GF-1-number 3(12mm) grommet die

Machine Code: GF-107 Universal Manual Hand Press

GF-107 Universal Manual Hand Press

GF-107 universal hand press is ideal for leathercraft , textile fabric applicatons ,eyeletting , rivetting, snaps fastener applications.

Gross weight:15 kg / 5 pcs inside box (seperated inside box)

Box dimension:55x35x25



Machine Code: GF-101 Small Grommet Hand Press -3 Year Warranty

GF-101 Small Grommet Hand Press Advantages ;

Practical ease of use.Interchangeable dies setting

Heavy duty durability.Easy to carry.

Suitable numerous materials.3 Year Warranty Parts and service available

Machine body made of high quality best quality iron casting raw material

Compatiable with all self piercing grommet & eyelet dies number #1.7 up to #3 , all size snap button dies, rivet dies, jean button dies.

GF-101 can attach maximum 12 mm inside hole grommet

Gross weight:10 kg / 5 pcs inside box (seperated inside box)

Box dimension:55x35x25

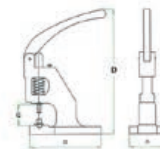

We can produce self piercing grommet made of brass metal , made of iron steel and made of stainless steel metal types upon customer request

Made of brass and made of iron steel metal is possible and available all galvanic color as below;

Nickel ,brass golden , antique brass, copper , copper oxide, black oxide and gun metal , mat nickel, antique nickel

Product codes:Size self piercing grommet +metal type+ color

Example #2 spgw made of brass color nickel 500 set

Self Piercing Grommet Sizes & Product Codes:

#1.7 SPGW #00 SPGW #0 SPGW #1-J SPGW #1 SPGW #2 SPGW #2L SPGW #2XL SPGW #3 SPGW #3L SPGW #3XL SPGW #4 SPGW #5 SPGW #5.5 SPGW

Packaging

#6,5SPGW

500 Pcs set per bag (500 pcs self piercing grommet + 500 pcs Washers)

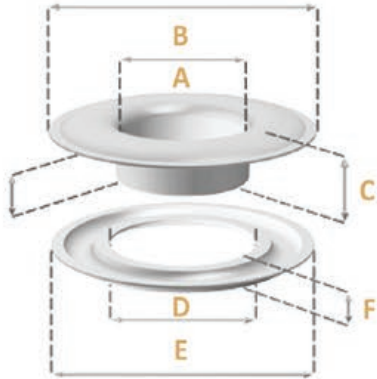

Brass Color



Nickel



Black Painted Color



White Painted Color

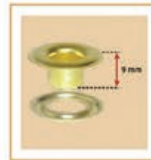

Long Neck 9 mm

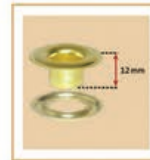

Long Neck 12 mm



Antique Brass



Black Oxide

Self Piercing		Grommet Dimensions			Washer Dimensions	
Size	Finishing	A	B	C	D	E
#1.7	Brass, Nickel Antique Brass, Black Oxide, Black Painted, White Painted	3,6 mm 5/32"	7 mm 9/32"	4 mm 1/8"	4 mm 1/8"	8 mm 5/16"
#00	Brass, Nickel Antique Brass, Black Oxide, Black Painted, White Painted	4,4 mm 3/16"	8,5 mm 5/6"	5 mm 2/16"	6 mm 1/4"	8mm 5/16"
#0	Brass, Nickel Antique Brass, Black Oxide, Black Painted, White Painted	5 mm 7/32"	9,5 mm 6/16"	5 mm 2/16"	6 mm 1/4"	9,5 mm 3/8"
#1-J	Brass, Nickel Antique Brass, Black Oxide, Black Painted, White Painted	6,35 mm 1/4"	11,5mm 7/16"	5,4mm 3/16"	7mm 9/32"	11,5mm 11/16"
#1	Brass, Nickel Antique Brass, Black Oxide, Black Painted, White Painted	8 mm 5/16"	15mm 9/32"	5,9mm 3/16"	9,2mm 3/8"	15mm 5/8"

Self piercing grommets and eyelets made of heavy duty brass material. Thickness 0,30 mm

#2 (Regular)	Brass, Nickel Antique Brass, Black Oxide, Black Painted, White Painted	9,5 mm 3/8"	19 mm 3/4"	5,8mm 3/8"	11 mm 7/16"	19,5 mm 3/4"
#2L (9mm Long Neck)	Brass, Nickel Antique Brass, Black Oxide, Black Painted, White Painted	9,5 mm 3/8"	19 mm 3/4"	9mm 5/16"	11 mm 7/16"	19,5 mm 3/4"
#2XL (12mm Long Neck)	Brass, Nickel Antique Brass, Black Oxide, Black Painted, White Painted	9,5mm 3/8"	11,5 mm 13/32"	12mm 13/32"	11mm 7/16"	19,5 mm 3/4"
#3 (Regular)	Brass, Nickel Antique Brass, Black Oxide, Black Painted, White Painted	11,6mm 7/16"	24,5mm 31/32"	6,5mm 7/16"	13mm 1/2"	24,5 mm 31/32"
#3L (9mm Long Neck)	Brass, Nickel Antique Brass, Black Oxide, Black Painted, White Painted	11,6mm 7/16"	24,6mm 31/32"	9mm 11/32"	13 mm 1/2"	24,5 mm 31/32"
#3XL (12mm Long Neck)	Brass, Nickel Antique Brass, Black Oxide, Black Painted, White Painted	11,6mm 7/16"	24,6 mm 31/32"	12mm 7/16"	13 mm 1/2"	24,5 mm 31/32"
#4	Brass, Nickel Antique Brass, Black Oxide, Black Painted, White Painted	15,6 mm 5/8"	28 mm 11/8"	6,5 mm 3/16"	16,5 mm 11/16"	28,5 mm 11/32"
#5	Brass, Nickel Antique Brass, Black Oxide, Black Painted, White Painted	18,2 mm 5/8"	31mm 11/8"	9,5mm 5/16"	17,5mm 11/16"	31mm 11/4"
#5.5	Brass, Nickel Antique Brass, Black Oxide, Black Painted, White Painted	18,2 mm 11/16"	28,5mm 11 7/32"	6,8mm 17/64"	19mm 3/4"	28mm 17/64"
#6,5	Brass, Nickel Antique Brass, Black Oxide, Black Painted, White Painted	20 mm	36 mm	8,1 mm	20,5 mm	36 mm



Number #4 spgw and number #5 spgw self piercing grommet have grip teeth washer feature.

Self Piercing Grommet Dies Made Of High Quality A4020 Stainless Steel

Grommet Die Product Codes & Sizes

#1,7 SPGD #00 SPGD #0 SPGD #1-J SPGD #1 SPGD

#2 SPGD #3 SPGD #4 SPGD #5 SPGD #5,5 SPGD

#6,5 SPGD



Note: #2 spgd grommet diesworks 3 size #2 SPGW, #2L SPGW, #2XL SPGW grommets.

Same dies #3 spgd grommet dies works 3 size #3 SPGW, #3L SPGW, #3XL SPGW grommet

Self Piercing Grommet & Auto Neck Washer Series-DIN works with full automatic grommet machines

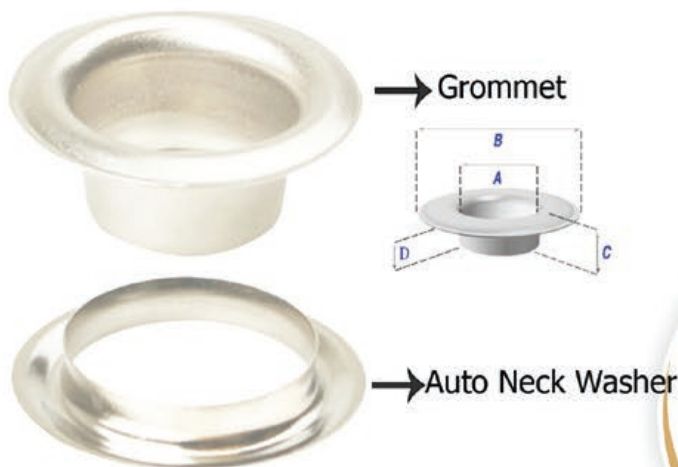

Product Code+metal type + color finishing

Made of steel metal available colors gold brass,nickel,black oxide, antique brass

Product Codes Self Piercing Grommet Auto Neck Washer :SPG-ANW

#0(5mm)SPG-ANW

#1-J(6,35)SPG-ANW

#1(8mm)SPG-ANW

#2(10mm)SPG-ANW

#2L(10mm)SPG-ANW

#3(12mm)SPG-ANW

#3L(12mm)SPG-ANW

#4(16mm)SPG-ANW

Made of brass metal available colors clean brass , gold brass,nickel,black oxide, antique brass

Packaging type:500 grommet+500 auto neck washer in PP bag seperated
 Box quantity bag 25 bag -50 bag ,10 bag ,20 bag according to size grommet
 We can produce made of brass , made of stainless steel 304 Inox, 316 stainless steel
 made of steel ,made of galvanized ,made of aluminum according to customer request.



Curtain Grommet Dies Made of High Quality Stainless Steel (All curtain grommet dies works with GF-3 GF-10-B ,machine)

Attacher Die



Product Codes

- # 7,5 Attacher Die (25mm)
- # 8,5 Attacher Die (30mm)
- # Gm28 Attacher Die (30mm)
- # 12 Attacher Die (40mm)
- # 15 Attacher Die (50mm)
- #18 Attacher Die(66mm)

All in One Die



Product Codes

- # 7,5 All in One (25mm)
- # 8,5 All in One (30mm)
- # Gm28 All in One (28mm)
- # 12 All in One (40mm)
- # 15 All in One (50mm)

Piercer Die



Product Codes

- # 7,5 Piercer Die (25mm)
- # 8,5 Piercer Die (30mm)
- # Gm28 Piercer Die (28mm)
- # 12 Piercer Die (40mm)
- # 15 Piercer Die (50mm)
- #18 Piercer Die(66mm)

High Quality Curtain Grommets & Washer

Curtain eyelet product codes

- #18(66mm)
- #15(50mm)
- #12LN(40mm)
- #12 SN(40mm)
- #8,5 (30mm)
- #7,5 (25mm)
- # GM28 (28mm)

We can produce curtain grommet made of brass , made of steel ,made of stainless steel raw material
 Product code+raw material type+color=Full product code

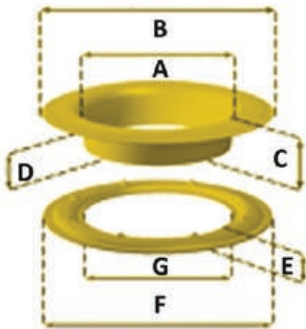

Pierced Washer

Plain Washer



CURTAIN GROMMET SIZE CHART (Ø=mm)

(" =Inch , inches)
 Inches dimensions-USA-UK

PRODUCT CODE	A	B	C	D	E	G	F	A	B	C	D	E	G	F
#18(66mm)	66Ø	96Ø	12Ø	11Ø	0,60Ø	96Ø	69Ø	2,59"	3,77"	0,47"	0,43"	0,23"	3,77"	2,71"
#15 (50 mm)	50Ø	80Ø	9Ø	8Ø	0,40Ø	49Ø	80Ø	2"	3,15"	0,35"	0,32"	0,015"	1,92"	3,14"
#12 LN (40 mm)	40Ø	62Ø	11Ø	9Ø	0,40Ø	42,7Ø	62Ø	1,5"	2,44"	0,43"	0,35"	0,015"	1,68"	2,44"
#12 SN (40 mm)	40Ø	62Ø	9Ø	8Ø	0,35Ø	42,7Ø	62Ø	1,5"	2,44"	0,35"	0,314"	0,013"	1,68"	2,44"
#7,5 (25 mm)	25Ø	44Ø	11Ø	9Ø	0,40Ø	26,2Ø	44Ø	0,98"	1,73"	0,43"	0,35"	0,015"	1,05"	1,73"
#8,5 (30 mm)	30Ø	50Ø	9Ø	8Ø	0,35Ø	31,2Ø	50Ø	1,12"	1,96"	0,35"	0,314"	0,013"	1,22"	1,96"
#Gm28 (28 mm)	28Ø	48Ø	9,8Ø	8Ø	0,35Ø	29,2Ø	48Ø	1,10"	1,88"	0,35"	0,314"	0,013"	1,14"	1,88"



Gromfast

Curtain Grommet Electroplating Galvanic Colors



Satin Nikel

Nickel

Mat Nickel

Antique Brass

Shinny Brass

Satin Mat Brass

Gun Metal

Copper

Copper Oxide (Bronze)

Chemical Black Oxide

Cream Painted

Polished Black Painted

Mat Black Painted

Antique Nickel

We can paint special color according to ral code color chart customer request.

Product Code:	Round	DIN Eyelet Series
	DIN10	(A)10mm x (B)20mm x (C)7,5mm
	DIN12	(A)12mm x (B)24mm x (C)8mm
	DIN16	(A)16mm x (B)30mm x (C)9 mm
	DIN18	(A)18mm x (B)31mm x (C)9,2mm
	DIN20	(A)20mm x (B)36mm x (C)9 mm
	DIN25	(A)25mm x (B)44mm x (C)11mm
	DIN40	(A)40mm x (B)62mm x (C)13mm

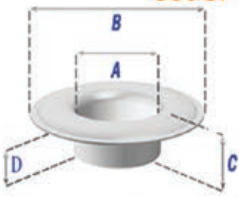

Oval DIN Series Dimensions

DIN 42x22 Oval	(A)42mm x (B)22mm x (C)12mm
DIN 40x20 Oval	(A)40mm x (B)20mm x (C)12mm
DIN 40x10 Oval	(A)40mm x (B)10mm x (C)13mm
DIN 22,5x13,5 Oval	(A)22,5mm x (B)13,5mm x (H)8mm
DIN 17x11 Oval	(A)17mm x (B)11mm x (H)7,5 mm

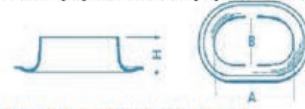

Grommet with normal washer works GF-104, GF-2, GF3, GF10,GF-10-B,GF20,GF-30 machines and dies according to size of grommet
 Note: Self Piercing grommet dies works DIN series 10mm,12mm,16mm ,18mm,20 mm DIN grommets,manual machines and semi automatic TIR series automatic grommet dies 40mm ,25mm,20mm ,42x22 ,40x20, 40x10 oval works GF-20,GF-30 grommet machines.
 TIR series 2 step all in one grommet dies 40mm ,25mm,20mm ,42x22 ,40x20, 40x10 oval works GF-10-B pneumatic grommet machine

- | | | |
|--------------------------------------|---|--------------------------------------|
| #18(66mm) Automatic Dies for GF-20, | 42x22 Oval Automatic Dies for GF-20 | #18(66mm) Automatic Dies for GF-30, |
| #15(50mm) Automatic Dies for GF-20, | 40x20 Oval Automatic Dies for GF-20 | #15(50mm) Automatic Dies for GF-30, |
| #12(40mm) Automatic Dies for GF-20, | 40x10 Oval Automatic Dies for GF-20 | #12(40mm) Automatic Dies for GF-30, |
| #8,5(30mm) Automatic Dies for GF-20, | 22,5x13,5 Oval Automatic Dies for GF-20 | #8,5(30mm) Automatic Dies for GF-30, |
| #GM28(28mm) Automatic Dies for GF-20 | 17x11 Oval Automatic Dies for GF-20 | #GM28(28mm) Automatic Dies for GF-30 |
| #7,5(25mm) Automatic Dies for GF-20 | 42x22 Oval Automatic Dies for GF-30 | #7,5(25mm) Automatic Dies for GF-30 |
| #6,5(20mm) Automatic Dies for GF-20 | 40x20 Oval Automatic Dies for GF-30 | #6,5(20mm) Automatic Dies for GF-30 |
| #5,5(18mm) Automatic Dies for GF-20 | 42x22 Oval Automatic Dies for GF-30 | #5,5(18mm) Automatic Dies for GF-30 |
| #5 (16,2mm) Automatic Dies for GF-20 | 40x20 Oval Automatic Dies for GF-30 | #5 (16,2mm) Automatic Dies for GF-30 |
| #4(15,6mm) Automatic Dies for GF-20 | 40x10 Oval Automatic Dies for GF-30 | #4(15,6mm) Automatic Dies for GF-30 |
| #3(12mm) Automatic Dies for GF-20 | 22,5x13,5 Oval Automatic Dies for GF-30 | #3(12mm) Automatic Dies for GF-30 |
| #2(10mm) Automatic Dies for GF-20 | 17x11 Oval Automatic Dies for GF-30 | #2(10mm) Automatic Dies for GF-30 |

CD:Cutting dies SD:Setting dies AID:All in one dies 2 step dies set



- Oval 42x22mm-CD
- Oval 40x20mm-CD
- Oval 40x10mm-CD
- Oval 22,5 x 13,5mm-CD
- Oval 17x 11mm-CD

- Oval 42x22mm-SD
- Oval 40x20mm-SD
- Oval 40x10mm-SD
- Oval 22,5 x 13,5mm-SD
- Oval 17x 11mm-SD

- #18(66mm) All In One Dies
- #15(50mm) All In One Dies
- #12(40mm) All In One Dies,
- #8,5(430mm) All In One Dies,
- #GM28(28mm) All In One Dies
- #7,5(25mm) All In One Dies
- #6,5(20mm) All In One Dies

All self piercing grommet dies made of stainless steel A4020 inox

10mm, grommet works #2 spgd , 12 mm grommet works #3 spgd , 16 mm grommet works #4 spgd
 18mm grommet works #5 spgd , 20 mm grommet works #6,5 spgd self piercing grommet dies

Twist Lock -Turnable Lock Button Plastic for 42x22 oval eyelet

TLB-PLS 42x22 Gray TLB-PLS 42x22 Cream TLB-PLS 42x22 Black TLB-PLS 42x22 Yellow
 TLB-PLS 42x22 Blue TLB-PLS 42x22 White TLB-PLS 42x22 Brown
 TLB-PLS 42x22 Red TLB-PLS 42x22 Orange TLB-PLS 42x22 Grey



Plastic Buckle 6x4 cm

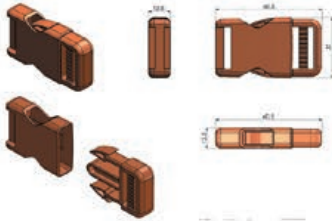

We can produce available gray,black,white,cream,brown,red, blue,green according rail code

Made of High Quality Stainless Steel Grommet Hand Tools

Hand Tool Sets



Hand Tool Piercer Rour



Stainless Steel Hand Tool Attacher



Hand tool attachers

- Product Code
- #SST #1.7 (3,5mm)HTA
 - #SST #00 (4,5mm)HTA
 - #SST #0 (5,5mm)HTA
 - #SST #1-J (6mm)HTA
 - #SST #1 (8mm)HTA
 - #SST #2 (10mm)HTA
 - #SST #3 (12mm)HTA
 - #SST #4 (16mm)HTA
 - #SST #5 (18mm)HTA
 - #SST #6,5 (20mm)HTA
 - #SST #7,5 (25mm)HTA
 - #SST #8,5 (30mm)HTA
 - #SST #12 (40mm)HTA
 - #SST-40x20mm-HTA
 - #SST-42x22mm-HTA

Hand Tool Piercer

- Product Code
- #SST #1.7(3,5mm)HTP
 - #SST #00(4,5mm)HTP
 - #SST #0 (5,5mm)HTP
 - #SST #1-J (6mm)HTP
 - #SST #1(8mm)HTP
 - #SST #1(10mm)HTP
 - #SST #3 (12mm)HTP
 - #SST #4 (16mm)HTP
 - #SST #5 (18mm)HTP
 - #SST #6,5 (20mm)HTP
 - #SST #7,5 (25mm)HTP
 - #SST #8,5 (30mm)HTP
 - #SST #12(40mm)HTP
 - #SST-40x20mm-HTP
 - #SST-42x22mm-HTP
 - #SST-40x10mm-HTP
 - #SST 29AxB6mm HTP for TIR Buckle
 - #SST 51AxB5.5mm HTP for TIR Staple

Oval 42x22 Hand Tool Piercer



Oval 42x22 Hand Tool Attacher



hollow punch duple for TIR buckle and staple

B (hole dimension)

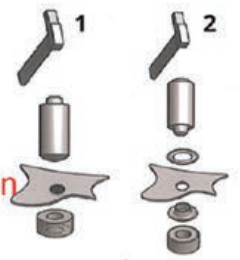

Packaging Type: Pvc vacum blister inlay with instruction

www.gromfast.com.tr



40mm round eyelet sets

Product code:#RSBTN 15mm-Inox-4 PART SET

- A-Part:Cap** Cap outside diameter:15mm
- B-Part:Socket** Socket outside diameter:12,5mm
- C-Part:Stud** Stud outside diameter:14mm
- D-Part:Post nail** Post Nail outside diameter:12mm
Post Nail Height:3 mm

15 mm Ring Snap Screw 4 part Set-Material Made of Inox SST

- A-Part:Cap** Cap outside diameter:15mm
- B-Part:Socket** Socket outside diameter:12,5mm
- D-Part:Inox Screw** 3,5 mm x 19 mm height made of inox
High quality stainless steel
Easy to use with screw driver montage
- C-Part:Stud** Stud outside diameter:14mm

Product code:#RSBTN 15mm-Inox-S19

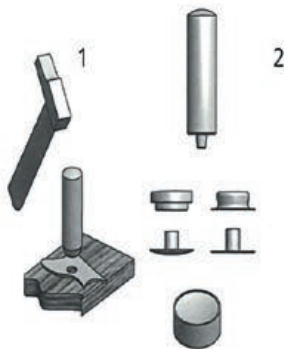

Packaging Type: Pvc vacum blister inlay with instruction +hand tool+snap fasteners 4 parts x15 pcs

Snap Fasteners Blister Sets product codes

- GF#RSBTN 15 MM INOX S19 SCREW AS 3 PART+S19 screw total 4 part X 15 PCS +HAND TOOL SET
- GF#RSBTN 15 MM INOX SET AS 4 PART X 15 PCS +HAND TOOL SET
- GF#RSBTN 15 MM MADE OF BRASS SET AS 4 PART X 15 PCS +HAND TOOL SET (optional colors available)

Grommet Blister Sets product codes

- GF#1-J(6,35 mm)JDYSP 25 made of high quality brass eyelets and washers +hand tool set
- GF#1 (8mm)JDYSP 25 made of high quality brass eyelets and washers +hand tool set
- GF#2 (10mm)JDYSP 25 made of high quality brass eyelets and washers +hand tool set
- GF#3(12mm)JDYSP 25 made of high quality brass eyelets and washers +hand tool set
- GF#4(16mm)JDYSP 25 made of high quality brass eyelets and washers +hand tool set
- GF#5,5 (18mm)JDYSP 25 made of high quality brass eyelets and washers +hand tool set
- GF#6,5 (20mm)JDYSP 25 made of high quality brass eyelets and washers +hand tool set
- GF#7,5 (25mm)JDYSP 25 made of high quality brass eyelets and washers +hand tool set
- GF#8,5 (30mm)JDYSP 20 made of high quality curtain brass eyelets and washers +hand tool set
- GF#12 (40mm)JDYSP 20 made of high quality curtain brass eyelets and washers +hand tool set
- GF#15 (50mm)JDYSP 20 made of high quality curtain brass eyelets and washers +hand tool set
- GF#18 (66mm)JDYSP 20 made of high quality curtain brass eyelets and washers +hand tool set

Packaging Type: Pvc vacum blister inlay with instruction+hand tool +Grommet and washer 25pcs set

Packaging Type: Pvc vacum blister inlay with instruction+hand tool +Grommet and washer 20pcs set

Hole Piercer Die Dimensions & Product Codes

#HPD 2mm	#HPD 2,5mm	#HPD 3mm
#HPD 3,5mm	#HPD 4mm	#HPD 4,5mm
#HPD 5mm	#HPD 5,5mm	#HPD 6mm
#HPD 6,5mm	#HPD 7mm	#HPD 7,5mm
#HPD 8mm	#HPD 8,5mm	#HPD 9mm
#HPD 9,5mm	#HPD 10mm	#HPD 10,5mm
#HPD 11mm	#HPD 11,5mm	#HPD 12mm
#HPD 12,5mm	#HPD 13mm	#HPD 13,5mm
#HPD 15,5mm	#HPD 16mm	#HPD 16,5mm



#HPD 14mm	#HPD 14,5mm	#HPD 15mm
#HPD 17mm	#HPD 17,5mm	#HPD 18mm

Ring Snaps Buttons & Dies

Ring Snaps Button

We Can Produce Any Design, Logo and Customized Color / DTM.

Ring Snap Dimensions & Product Codes

#RSBTN 12,55mn	#RSBTN 15mm	#RSBTN 17mm	#RSBTN 20 mm
----------------	-------------	-------------	--------------

Packing : 720 pcs set as 4 part - Cap-Socket-Stud-Post

Colors : Nickel, Brass, Antique Brass, Gun Metal, Black Oxide

Made of brass
Made of steel

Free Nickel Antique Brass Gun Metal Black Oxide Brass



15 mm Ring Snap 4 part Set-Material Made of Brass



Product code:#RSBTN 15mm

Made of Inox stainless steel metal

Ring Snaps Button Dies

Ring Snap Die Dimensions & Product Codes

We can produce full automatic snap attaching machine for all ring snaps buttons

#RSD-12,5 mm 4 part	#RSD-15 mm 4 part	#RSD-17 mm 4 part	#RSD-20 mm 4 part
---------------------	-------------------	-------------------	-------------------

Ring snap button dies sets 4 part for machines



Ring snap dies works with all manual machines and semi automatic GF-10 and GF-10-B

Spring Snaps

Packaging

720 pcs as 4 parts set

Colors : Nickel, Brass, Antique Brass, Gun Metal, Black Oxide

Using Materials : Brass , stainless steel inox and steel

Product Codes

#SPBTN 12,55 mm

#SPBTN 15mm

#SPBTN 17mm

#SPBTN 20 mm



Spring Snaps Die

Packaging

Spring Snap Die as 4 parts set (Made of stainless steel)

Product Codes

#SPD 12,55 mm 4 part

#SPD 15 mm 4 part

#SPD 17 mm 4 part

#SPD 20 mm 4 part

Colors : Nickel, Brass, Antique Brass, Gun Metal, Black Oxide



Open Cap Prong Snap Fastener

Packaging

720 pcs as 4 parts set

Colors : Nickel, Brass, Antique Brass, Gun Metal, Black Oxide

Using Materials : Made of brass , made of stainless steel inox

7,8 mm prong snap



10,5 mm prong snap



8,2 mm prong snap



15 mm prong snap



9,5 mm prong snap



21 mm prong snap



Open Cap Prong Snap Fastener Dies Sets

Open cap prong snap fastener dies as 2 parts for manual machines, GF-104,GF-101,GF-2GF-10 semi automatic machines

Open cap prong snap fastener dies sets products codes:7,8mmPSDS,8,2mmPSDS,9,5mmPSDS,10,5mmPSDS, 15mmPSDS,21mmPSDS

Closed Cap Prong Snap Fastener

Packaging

720 pcs as 4 parts set

Colors : Nickel, Brass, Antique Brass, Gun Metal, Black Oxide

Using Materials : Made of brass metal , made of inox metal stainless steel



7,5 mm cap prong snap



8,5 mm cap prong snap



9,5 mm cap prong snap



10,5 mm cap prong snap



15 mm cap prong snap



21 mm cap prong snap



Closed Cap Prong Snap Fastener Dies Set

Closed cap prong snap fastener dies as 3 parts for manual machines, GF-104,GF-101,GF-2,GF-10 semi automatic machines
 Closed cap prong snap fastener dies sets products codes:7,5mmCPSDS,8,5mm,CPSDS,9,5mm,CPSDS10,5mm,CPSDS 15mm,CPSDS,21mm



Double Cap Rivets

Double Cap Rivets Materials: Brass & Stainless Steel

Packaging

500 pcs set as 2 part Colors: Nickel, Brass, Antique Brass, Gun Metal, Black Oxide

Double Cap Rivet



Double Cap Rivets Dimensions & Product Codes

#DBRVT-5mm

DBLRVT 6mm

#DBLRVT-9mm

#DBLCRVT-12mm

Double Cap Rivets Die Dimensions & Product Codes

#DBRVD-5mm

DBLRVD 6mm,

#DBLRVD-9mm

Antique Brass

Black Oxide



Brass Color

Gun Metal



Nikel Color

Single Cap Rivet

Packaging

720 pcs as 4 parts set

Colors : Nickel, Brass, Antique Brass, Gun Metal, Black Oxide

Using Materials : Made of brass , made of steel

Single cap rivet product codes: #SCRVT-5mm, #SCRVT-6mm, #SCRVT-9mm, #SCRVT-12mm

Single cap rivet die product codes: #SCRVD-5mm-, #SCRVD6mm, #SCRVD 9mm, #SCRVD-12mm

Single cap rivet

Single cap rivet die



Upholstery Covered Buttons & Nail Covered Buttons

Covered Buttons



Covered Buttons sizes: No: 20, 22, 24, 26, 28, 30, 32, 36, 40, 44, 50, 60



Nail Covered Buttons



Auto cover slide dies



H: Under flange height
D: Diameter head

GF-3 full pneumatic covered button machine set

Cutting Tools



GF-3 semi pneumatic covered button machine set



Head of nail covered button air gun tool



Nail covered button air gun

Gromfast Metal Round Strap Staple

Product Code: **Strap Staple 21 mm**

- Strap cramp with round bracket for tarpaulin
- Total length: 66mm
- overall width: 15mm
- Stirrup inner height -h : 21mm
- inside width of stirrup: 26mm
- Hole spacing approx-a : 51 mm
- Ø hole: 5mm
- Galvanized steel

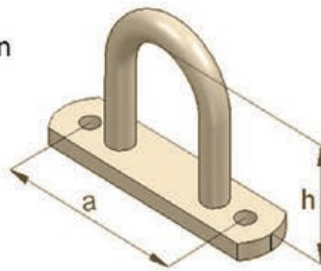

Product Code: **Strap Staple 25 mm**

- Stirrup inner height -h : 25mm

Product Code: **Strap Staple 30 mm**

- Stirrup inner height -h : 30mm

Product Code: **Strap Staple 38 mm**

- Stirrup inner height -h : 38mm

Note: All Strap Staples 500 pcs in box

We can produce made of stainless steel upon customer request

Product Code: **Strap Staple Cramp rectangle 15mm**

Belt staple for slotted eyelet

- suitable for slotted eyelets 38x8mm and 40x10mm
- total length: 66mm
- overall width: 15mm
- stirrup inner height: 25mm
- inside width of shackle: 26mm
- Hole spacing approx. 51mm
- Ø hole: 5mm
- Galvanized steel

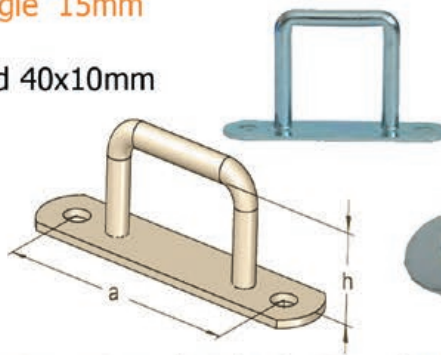

Strap Staple Cramp rectangle 20mm, (- stirrup inner height: h:20mm) we can produce made of stainless steel

Strap Staple Cramp rectangle 25mm, (- stirrup inner height: h:25mm) upon customer request.

Strap Staple Cramp rectangle 30mm, (- stirrup inner height: h:30mm) 500 pcs in box all strap staple cramps

Strap Staple Cramp rectangle 35mm, (- stirrup inner height: h:35mm)

Product Code: **Strap Staple P Cramp**

- stirrup inner height h: 30mm
- Hole spacing approx.a: 55mm
- Galvanized steel

we can produce made of stainless steel upon customer request all strap staple cramps.



Product Code: **Square Strap Staple 21mm**

- h: 21 mm
- a: 26 mm
- Made of galvanized



Product Code: **Metal Lock Button 42x22**

- Metal twist lock for tarpaulin
- suitable for oval eyelet 42 x 22mm
- steel galvanized
- hole distance approx. 51mm



Product Code: **Square Strap Staple 26mm**

- h: 26 mm
- a: 26 mm
- Made of galvanized

Product Code: **Rocking Staple 25mm**

- h: 25 mm
- a: 30 mm
- Made of galvanized

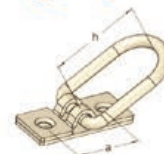

Product Code: **Square Strap Staple 30mm**

- h: 30 mm
- a: 26 mm
- Made of galvanized

Product Code: **Rocking Staple 30mm**

- h: 30mm
- a: 30 mm
- Made of galvanized

Gromfast >>> Strap Staple Cramps Fasteners

Product Code:Rocking Staple Big Type 25mm

h:25mm

a:51 mm

Made of galvanized



Product Code:Rocking Staple Big Type 37mm

h:37mm

a:51 mm

Made of galvanized

Product Code:Rocking Staple Big Type 45mm

h:45mm

a:51 mm

Made of galvanized

Gromfast >>> Over Center Buckles

Product Code:Over Center Buckle 58x182-SST

Made of Stainless Steel 430 quality or 304 quality

We can produce upon customer choose sst type request

Product Code:Over Center Buckle 58x182-Galvanized

Made of Galvanized

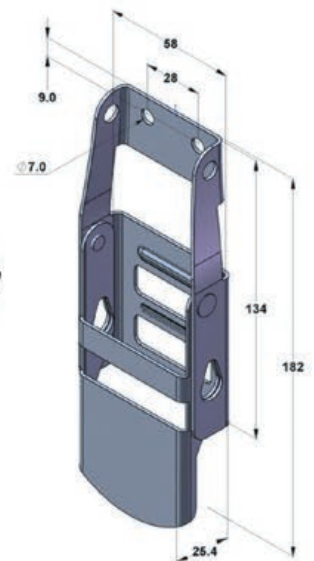

Product Code:Over Center Buckle Small 58x160-Galvanized
Made of Galvanized

Product Code:Over Center Buckle Small 58x160-SS
Made of Stainless Steel quality 430 and 304 quality

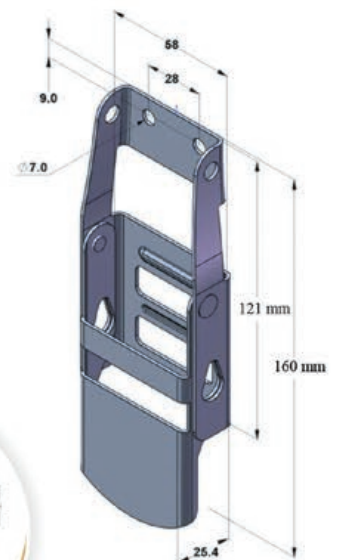
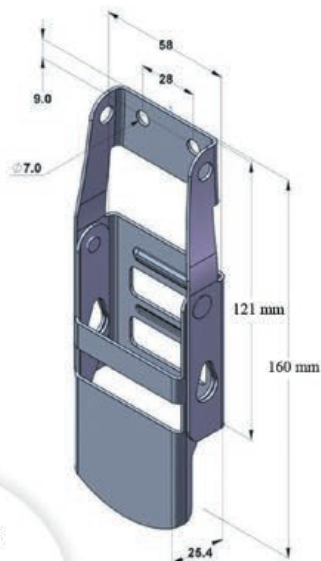

Product code:
Buckle Plate Galvan
without screw

Product code:
Buckle Plate Sst-without screw

Product code:
Buckle Plate Sst-with screw

Product code:
Buckle Plate galvanized with screw

Product code:
Buckle Plate Plastic with screw

Gromfast Hooks & Webbing Sets

Product Code: **FLAT HOOK FOR OVER CENTER BUCKLE Galvanized**

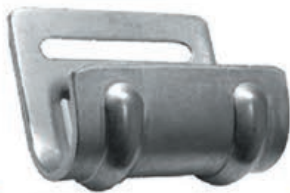

Product Code: **Closed Rave Hook FOR OVER CENTER BUCKLE GALVANIZED**



Product Code: **FLAT HOOK FOR OVER CENTER BUCKLE Stainless Steel**



Product Code: **Closed Rave Hook FOR OVER CENTER BUCKLE Stainless Steel**



Product Code: **A type HOOK FOR OVER CENTER BUCKLE GALVANIZED**



Product Code: **Flat HOOK with webbing set GALVANIZED**



Product Code: **A type HOOK FOR OVER CENTER BUCKLE Stainless Steel**



Product Code: **Flat HOOK with webbing set Stainless Steel**



Product Code: **Closed Rave HOOK with webbing set GALVANIZED**



Product Code: **A Type HOOK with webbing set GALVANIZED**



Product Code: **Closed Rave HOOK with webbing set Stainless Steel**



Product Code: **A Type HOOK with webbing set Stainless Steel**



Product Code: Plastic & Steel
TIR Cable 8 mm Thickness 1000 meter



We can produce according to customer needs meter request sets

Product Code: Plastic & Steel
TIR Cable 6 mm Thickness 1000 meter



Product Code: Plastic & Steel TIR Cable
8 mm Thickness 35 meter with Stoper Set



Product Code: Plastic & Steel TIR Cable
6 mm Thickness 35 meter with Stoper Set



Product Code: TIR CABLE STOPER
SET AS 3 PART



Product Code: ELASTIC CORD
STOPER WITH SIMPLEX SNAPHOOK



Product Code: PLASTIC & STEEL CABLE 4 MM THICKNESS
FOR TIR ROOF 1000 METER



Product Code: Elastic cord
6mm coild 150 meter
Optional Colors : Black , White, Gray,
(Mix Black & White)



Product Code: Elastic cord 6 mm
with metal hook set
(packaging 60 pcs in bag)



Product Code: Elastic cord 6 mm
with plastic hook set
(packaging 60 pcs in bag)



Product Code: Elastic cord 6 mm x 14 meter
with stoper simplex snaphook set



Product Code: Elastic cord 6 mm
Baggage with double stoper set 1,2 meter



We can produce 8 mm elastic cord according to customer request

We can produce according to customer needs meter request sets

Gromfast Tarpaulin Accessories

Product Code: Plastic hook for elastic cord



Steel hook packaging 500 pcs in bag
Plastic hook packaging 250 pcs in bag
Clips Plastic hook packaging 250 pcs in bag

Product Code: Metal Orings

No:14 inside hole 28,5mm
No:16 inside hole 31,5mm
No:18 inside hole 36 mm
No:20 inside hole 42 mm
No:50 inside hole 51,5mm
No:65 inside hole 64mm
No:70 inside hole 73 mm



Product Code: Steel hook for elastic cord



Product Code: Clips plastic hook for elastic cord



Product Code: D rings
D1:50mm width x 44mm height
D2:54,5mm width x 47mm height



Product Code: S hook 3mm thickness



Product Code: Plastic closed hook for stretch



Product Code: Metal Buckle Set 2 cm width
Metal Buckle Set 3cm width



Product Code: Stretch Mechanism p type left side +right side 2 pcs set



Product Code: Plastic opened hook for stretch



Product Code: Stretch Mechanism square head type left side +right side 2 pcs set



Product Code: Stretch Mechanism Krone type left side +right side 2 pcs set



Product Code: Stretch Mechanism 50mm left side +right side 2 pcs set



Product Code: Spanzet 25mm width 800-1500 N-10 meter double hook



Product Code: Stretch Mechanism T type left side +right side 2 pcs set



Product Code: Safety Locked Spanzet 48mm width 2500-5000N-10 meter double metal hook



Product Code: Pvc Cord 8 mm -1000 meter coil
Pvc Cord 10 mm -1000 meter coil



Product Code: Weldable webbing white 1300N/2400N
gray 1300N/2400N
cream 1300N/2400N



Product Code: PP webbing 50 mm width for over center buckle



Product Code: hook and loop 3 cm white and black optional



Product Code: Zipper type 20



Type 20 zipper
25 meter coil
Customize coil meter

Product Code: slider type 20



Product Code: Zamak Spanzet Stretch Buckle
3cm, 4cm ,5 cm width available

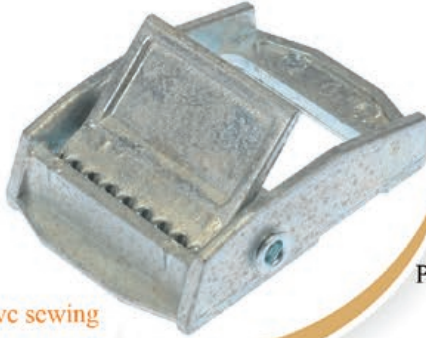

Product Code: Adapter Square type 35mm set



Product Code: Nylon yarn for pvc sewing



Product Code: Adapter flat type 35mm set



We can produce special order adapter upon customer request

Product Code:
Flat type roller
30mm x100mm steel wheel



Product Code:
Z type roller
30mm x100mm
plastic wheel



Product Code:
Flat type roller
30mm x100mm plastic wheel

Product Code: Adapter L type set



Product Code: Adapter round type set



Product Code:
6 wheel roller
steel wheel



Product Code:
roller double wheel
50 mm for column
plastic wheel



Product Code:
roller double wheel
50 mm for column
steel wheel



Product Code:
Flat type roller
steel wheel



Product Code:
4 wheel Z type roller
steel wheel



Product Code:
Rivetting roller
steel wheel



Product Code:
Duo trio roller
steel wheel



Product Code:
Triangle roller
steel wheel



Product Code:
TSE type 4 sheel roller
steel wheel



Product Code:
Roof slide plastic V type 650 mm



Product Code:
Roof slide plastic 570 mm
Roof slide plastic 650 mm



Product Code:
Roof slide plastic Krone type



Product Code:
Roof slide plastic 500+70 mm
Roof slide plastic 600 mm
Roof slide plastic 650 mm



Product Code:
Roof slide metal plate



Product Code:
Side rain tire



Product Code:
Roof slide plastic S type



Product Code:
Roof overhang tire



Product Code:
Roof rain tire



Product Code:
Roof ceiling buckle rulo set
(60 meter rulo)



Product Code:
Roof slide piston



Product Code:
Roof ceiling fastening buckle set



Product Code:
Roof ceiling fastening buckle



Product Code: Roof slide capsule
40mm big type



Product Code:
Roof slide capsule
24mm small type



Product Code:
Back winding pipe 3 meter
Back winding pipe 3,3 meter
(optional height)1,08 kg/meter



Product Code:
Roof ceiling fastening buckle set



Product Code:
Roof ceiling fastening buckle



Product Code:
Aluminium Profile Board for wood
6 meter



Product Code:
Rain Protection Rail
Aluminum 1,1 kg/meter

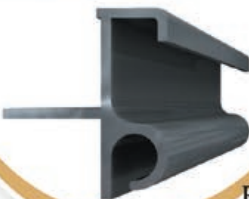

Product Code:
Schmitz Type-27 mm
Back winding pipe 3 meter
0,7kg/meter Aluminum



Product Code:
Aluminium Profile 50 mm

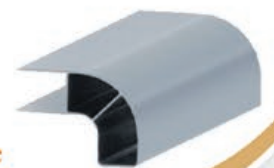

Product Code:
Fender Clamp 42 mm



Product Code:
Aluminum cargo keeper
2 pcs set



Product Code:
Aluminium Profile V type
For trailer left and right side
25mm width x100 mm height



Gromfast TRANSPARENT PVC

Pvc cristal transparent optional thickness 0,40mm /500 gram m2, 0,50 mm /620 gr/m2
0,60 mm/750 gr/m2 , 0,80 mm/1000gr/m2, 1 mm/1250 gr/m2, 2mm/2500 gr/m2
3mm/3750 gr/m2

Roll width 1,5 meter optional 1,8 meter, Heat Resistance +68 /-28 Celsius



Gromfast PVC COATED FABRICS



RAL 1000	RAL 1001	RAL 1002	RAL 1003	RAL 1004	RAL 2001	RAL 2004	RAL 2006	RAL 2009	RAL 2010
RAL 1005	RAL 1006	RAL 1007	RAL 1011	RAL 1012	RAL 2011	RAL 2012	RAL 2000	RAL 2003	RAL 2002
RAL 1013	RAL 1014	RAL 1015	RAL 1016	RAL 1017	RAL 2003	RAL 2004	RAL 2005	RAL 2007	RAL 2009
RAL 1018	RAL 1019	RAL 1020	RAL 1021	RAL 1023	RAL 2011	RAL 2012	RAL 2013	RAL 2014	RAL 2015
RAL 1024	RAL 1027	RAL 1028	RAL 1032	RAL 1033	RAL 2016	RAL 2017	RAL 2018	RAL 2020	RAL 2022
RAL 1034	RAL 1037	RAL 2000	RAL 2001	RAL 2002	RAL 2002	RAL 2007	RAL 3031	RAL 4001	RAL 4002
RAL 4003	RAL 4005	RAL 4006	RAL 4007	RAL 4008	RAL 6009	RAL 6001	RAL 6002	RAL 6003	RAL 6004
RAL 4009	RAL 4010	RAL 5000	RAL 5001	RAL 5002	RAL 6003	RAL 6006	RAL 6007	RAL 6008	RAL 6009
RAL 3003	RAL 5004	RAL 5005	RAL 5007	RAL 5008	RAL 6010	RAL 6011	RAL 6012	RAL 6013	RAL 6014
RAL 5009	RAL 5010	RAL 5011	RAL 5012	RAL 5013	RAL 6015	RAL 6016	RAL 6017	RAL 6018	RAL 6019
RAL 5014	RAL 5015	RAL 5017	RAL 5018	RAL 5019	RAL 6020	RAL 6021	RAL 6022	RAL 6024	RAL 6025
RAL 5020	RAL 5021	RAL 5022	RAL 5023	RAL 5024	RAL 6026	RAL 6027	RAL 6028	RAL 6029	RAL 6032
RAL 6033	RAL 6034	RAL 7000	RAL 7001	RAL 7002	RAL 7044	RAL 7045	RAL 7046	RAL 7047	RAL 8000
RAL 7003	RAL 7004	RAL 7005	RAL 7006	RAL 7008	RAL 8001	RAL 8002	RAL 8003	RAL 8004	RAL 8007
RAL 7009	RAL 7010	RAL 7011	RAL 7012	RAL 7013	RAL 8008	RAL 8011	RAL 8012	RAL 8014	RAL 8015
RAL 7015	RAL 7016	RAL 7021	RAL 7022	RAL 7023	RAL 8016	RAL 8017	RAL 8019	RAL 8022	RAL 8023
RAL 7024	RAL 7026	RAL 7030	RAL 7031	RAL 7032	RAL 8024	RAL 8025	RAL 8028	RAL 9001	RAL 9002
RAL 7033	RAL 7034	RAL 7035	RAL 7036	RAL 7037	RAL 9003	RAL 9004	RAL 9005	RAL 9006	RAL 9007
RAL 7038	RAL 7039	RAL 7040	RAL 7042	RAL 7043	RAL 9010	RAL 9011	RAL 9016	RAL 9017	RAL 9018

Product Code: **TIR-650 GRAM/m2**

Technical Specifications

Yarn: 1100 Dtex

Tensile Strength: 2500N/5cm

Temperature Resistance: - 30C / + 75C

We are able to supply MAT, GLOSSY or

EMBOSS surfaces with FR, Anti-Static,

High UV Protection, Antifungal, Top Side or Both Sides

Lacquered options in regards to our customers' demands.

Width: 150cm-250cm-300cm-320cm optional

Product Code: **TIR-680 GRAM/m2**

Technical Specifications

Yarn: 1200 Dtex

Tensile Strength: 2800N/5cm

Temperature Resistance: - 30C / + 75C

We are able to supply MAT, GLOSSY or

EMBOSS surfaces with FR, Anti-Static,

High UV Protection, Antifungal, Top Side or Both Sides

Lacquered options in regards to our customers' demands.

Width: 150cm-250cm-300cm-320cm optional

Product Code: **TIR-900 GRAM/m2**

Technical Specifications

Yarn: 2100 Dtex

Tensile Strength: 4250N/5cm

Temperature Resistance: - 30C / + 75C

We are able to supply MAT, GLOSSY or

EMBOSS surfaces with FR, Anti-Static,

High UV Protection, Antifungal, Top Side or Both Sides

Lacquered options in regards to our customers' demands.

Width: 150cm-250cm-300cm-320cm optional



Gromfast Tent Awnings Pergola Fasteners

Product Code: Awnings manual mechanism set

Optional width: 1,5 meter , 2 meter , 2,5 meter, 3 meter 3,5 meter



Product Code: Bellows awnings strap

Product Code: Bellows awnings hinge
Plastic 8 pcs in bag



Product Code: Bellows awnings hinge
Aluminum 8 pcs in bag



Product Code: Bellows awnings roller
Plastic 8 pcs set as 4 part



Product Code: Tent Pegs Galvanized





"Gromfast Always Best"

Gromfast



GROMFAST METAL SAN. ve TİC. A.Ş.
İkitelli O.S.B. İsteks San.Sit. B6 Blok No:9 Başakşehir / İSTANBUL

 +90 212 485 91 19 Fax : 0212 485 91 19

 info@gromfast.com.tr



[gromfastmetal](https://www.instagram.com/gromfastmetal)



[gromfastmetal](https://www.facebook.com/gromfastmetal)

www.gromfast.com.tr